



**Supplier of Quality  
Window Accessory Profiles  
and Customized Extrusions**

---

**REGENEX CORPORATION**

P.O. BOX 608 • ONE NEW STREET • WEST MIDDLESEX, PA 16159  
724-528-5900 • FAX 724-528-5903 • E-MAIL [info@regenex.com](mailto:info@regenex.com) • [www.regenex.com](http://www.regenex.com)

---

---

# TABLE OF CONTENTS

---

---

<b>Head Expanders.....</b>	<b>2</b>
<b>Balance Covers.....</b>	<b>7</b>
<b>Sash Stops.....</b>	<b>9</b>
<b>Mullions.....</b>	<b>11</b>
<b>Slider Track Fillers.....</b>	<b>13</b>
<b>Sill &amp; Trim Angles.....</b>	<b>14</b>
<b>Other Trims.....</b>	<b>16</b>
<b>Sill Extenders.....</b>	<b>17</b>
<b>Nail Fins.....</b>	<b>19</b>
<b>Glazing Beads/Glass Stops.....</b>	<b>21</b>
<b>Screen Track Fillers.....</b>	<b>23</b>
<b>Adapters.....</b>	<b>24</b>
<b>Miscellaneous Profiles.....</b>	<b>25</b>

---

---

# HEAD EXPANDER

---

---

**NOTE: Regenex can make customized profiles to meet your needs.**

**(Shown Actual Size)**

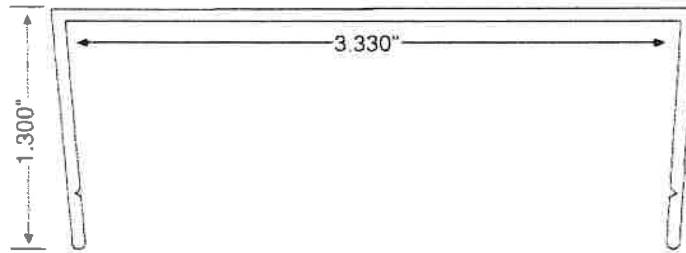

**1001**

---

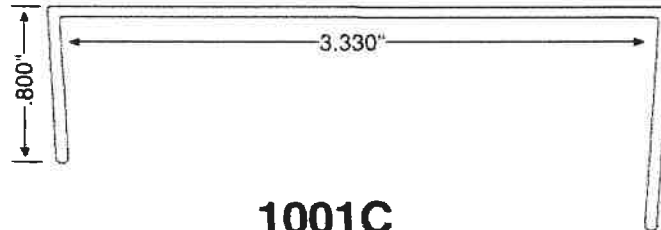

**1001C**

---



**1001R**

---

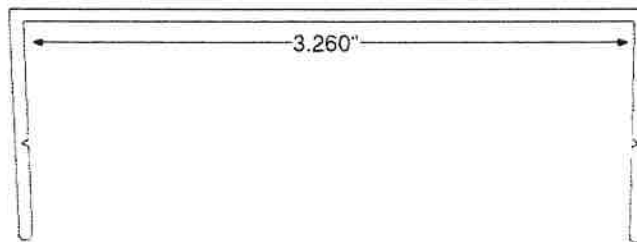

**1009**

---

---

# HEAD EXPANDER

---

---

**NOTE: Regenex can make customized profiles to meet your needs.**

**(Shown Actual Size)**

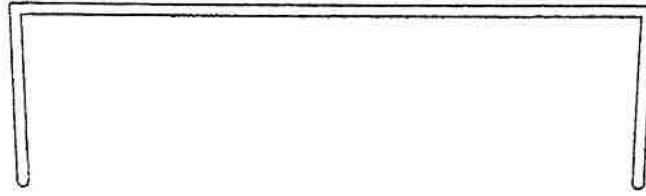

**1009A**

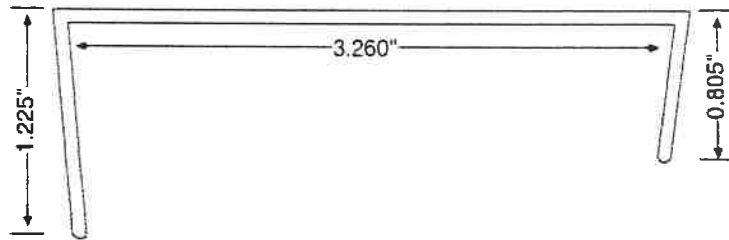

**1009C**

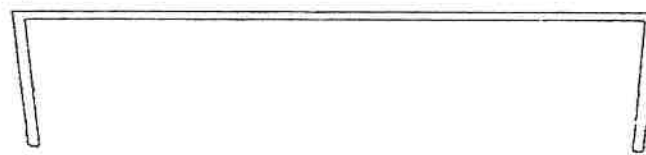

**1009M**

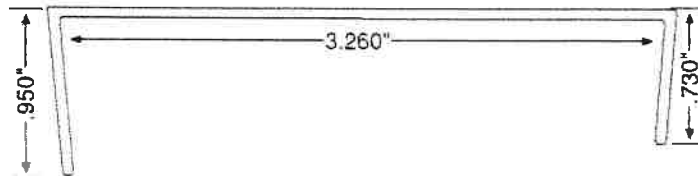

**1009P**

---

---

# HEAD EXPANDER

---

---

**NOTE: Regenex can make customized profiles to meet your needs.**

(Shown Actual Size)



**1009R**

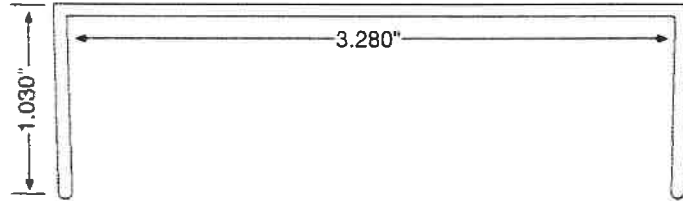

**1020**

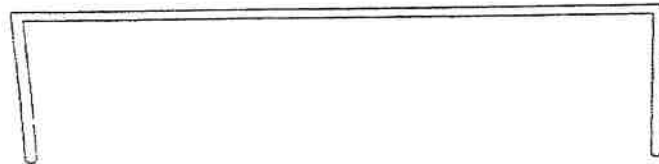

**1020B**

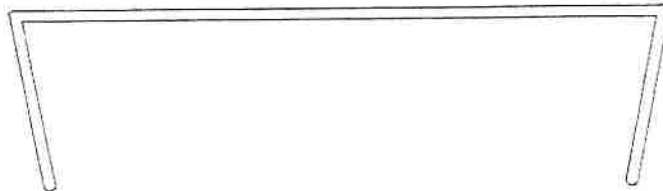

**1020D**

---

---

# HEAD EXPANDER

---

---

**NOTE: Regenex can make customized profiles to meet your needs.**

**(Shown Actual Size)**

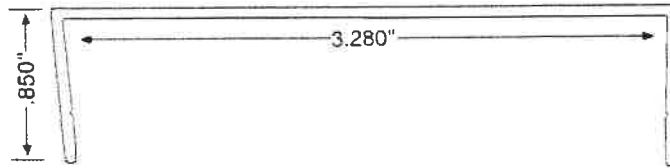

**1020M**

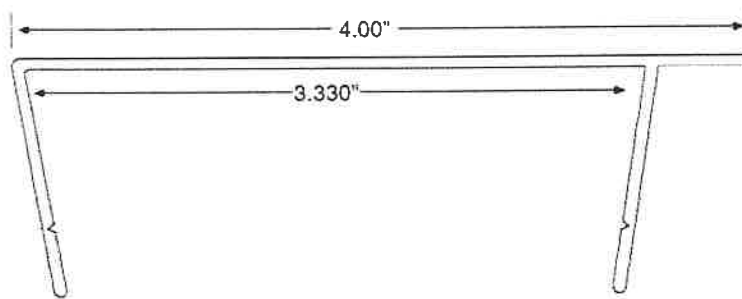

**1025**

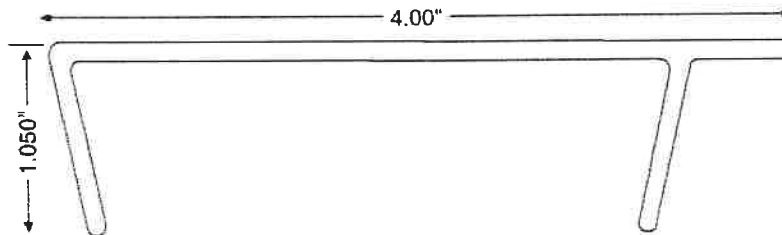

**1025B**

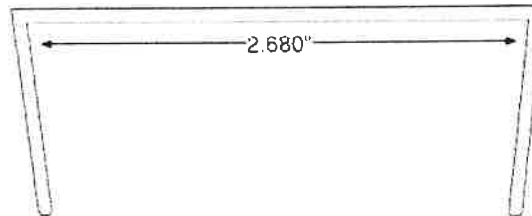

**2004**

---

---

# HEAD EXPANDER

---

---

**NOTE: Regenex can make customized profiles to meet your needs.**

**(Shown Actual Size)**



**2063**

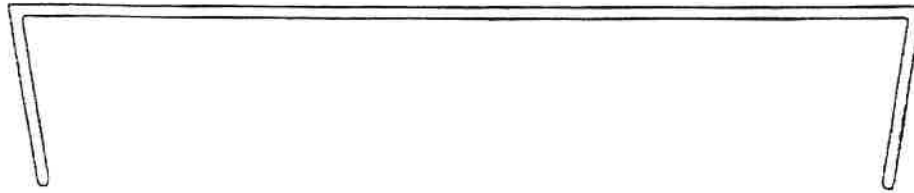

**2516**

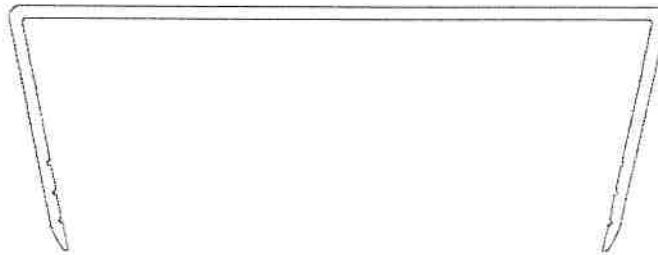

**4004**

# BALANCE COVERS

NOTE: Regenex can make customized profiles to meet your needs.

(Shown Actual Size)



**1006**



**1007**



**1029**



**1031**



**1051**



**1071**



**1075**



**1104**



**1108**



**1110**



**1115**

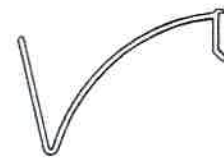

**1170**



# BALANCE COVERS

NOTE: Regenex can make customized profiles to meet your needs.

(Shown Actual Size)



**1251**



**2012**

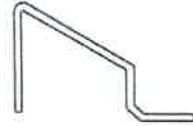

**2018**

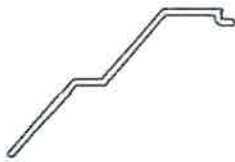

**2045**



**2045T**

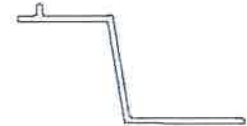

**2059**



**2080**



**2104**

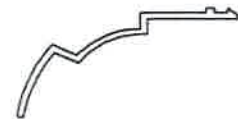

**2302**

# SASH STOPS

NOTE: Regenex can make customized profiles to meet your needs.

(Shown Actual Size)



**1004**



**1022**



**1032**



**1046**



**1055**



**1065**



**1089**



**1229**

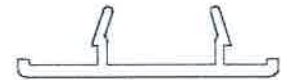

**1230**



**2006**



**2013**



**2021**



**2024**



**2035**



**2041**

# SASH STOPS

NOTE: Regenex can make customized profiles to meet your needs.

(Shown Actual Size)



**2043**



**2044**



**2049**



**2156**



**2167**

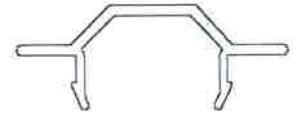

**2197**



**2201**

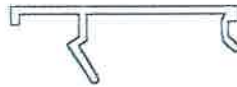

**2301**



**2517**



**2601**

# MULLIONS

NOTE: Regenex can make customized profiles to meet your needs.

(Shown Actual Size)

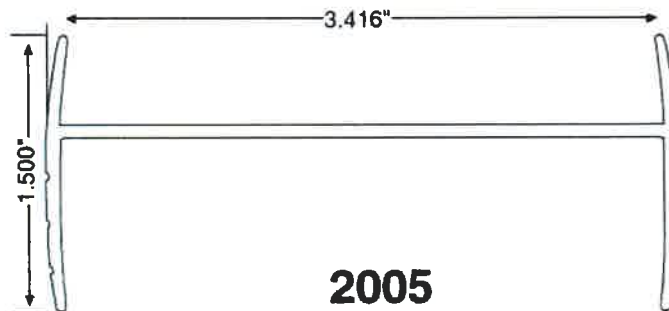
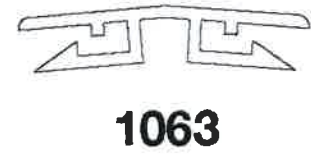
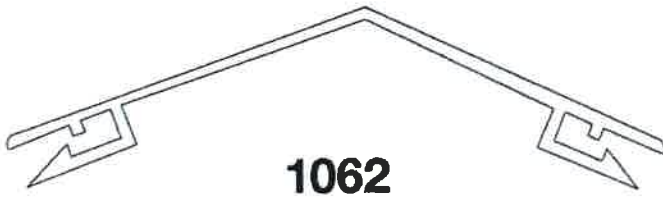
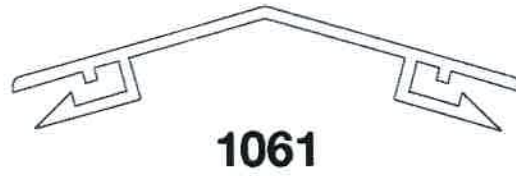
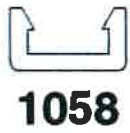
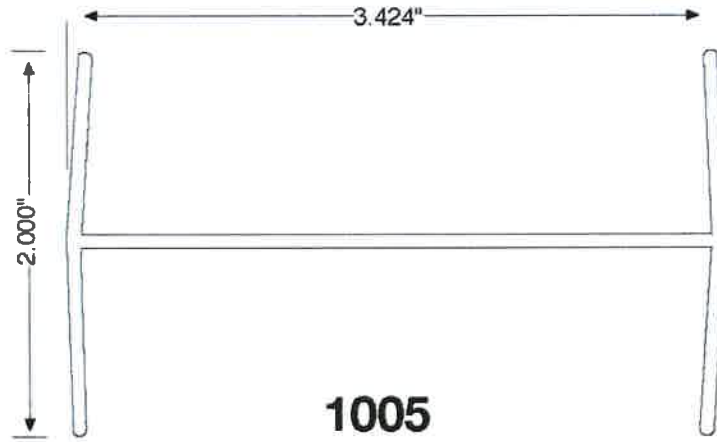

# MULLIONS

**NOTE: Regenex can make customized profiles to meet your needs.**

(Shown Actual Size)

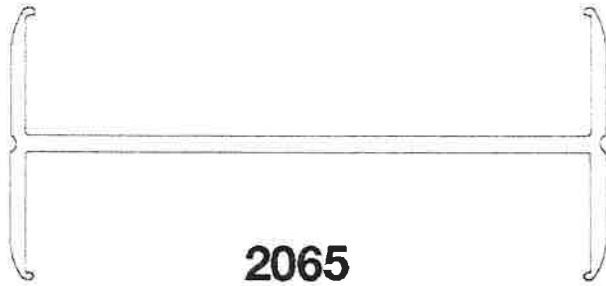

**2065**

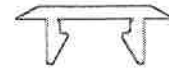

**2173**

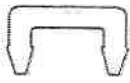

**2203**



**2233**



**2428**



**2537**

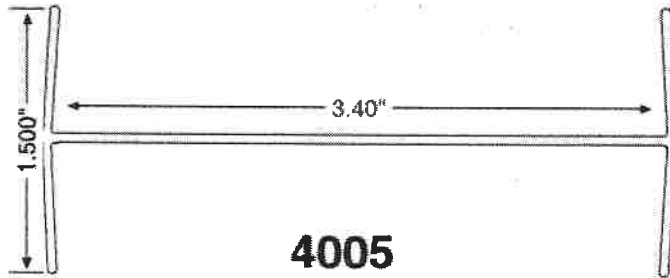

**4005**

# SLIDER TRACK FILLERS

NOTE: Regenex can make customized profiles to meet your needs.

(Shown Actual Size)

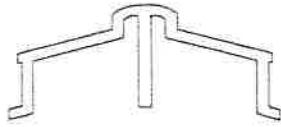

1012

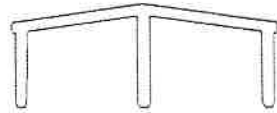

1013



1018

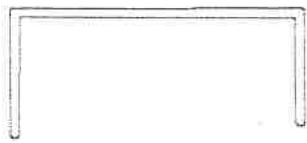

1024

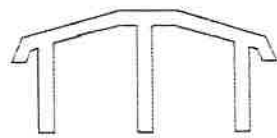

1035

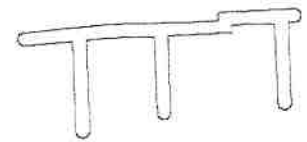

1078

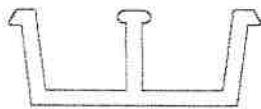

1231

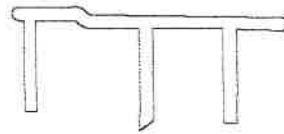

2000



2017

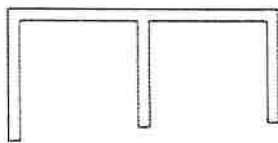

2022

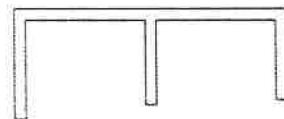

2023

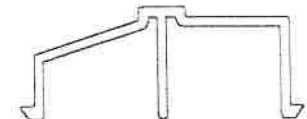

2077

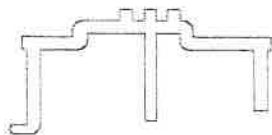

2082

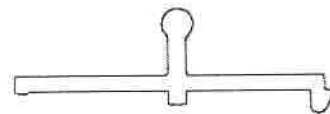

2427

# SILL & TRIM ANGLES

NOTE: Regenex can extrude any size angle to meet your needs.

(Shown Actual Size)

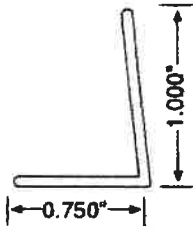

**1002**



**1002R**

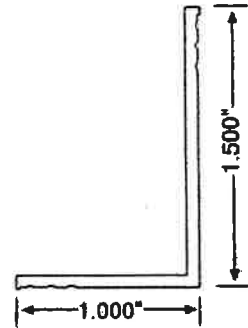

**1003**

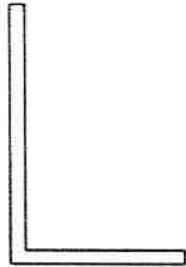

**1003B**



**1120**



**1211**

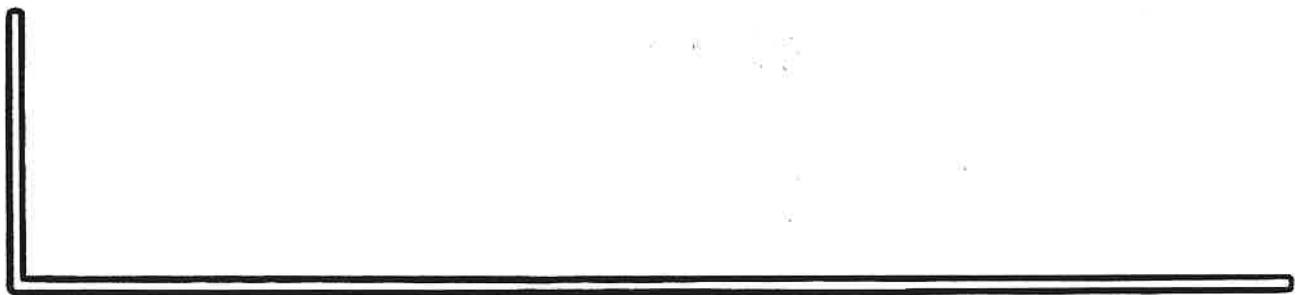

**1073**

# SILL & TRIM ANGLES

NOTE: Regenex can extrude any size angle to meet your needs.

(Shown Actual Size)



**1250**



**1250A**



**1250B**



# Other Trim

NOTE: Regenex can extrude any size angle to meet your needs.

(Shown Actual Size)



**1011**



**1017**



**1080**

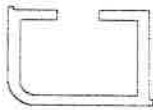

**1082**



**2057**



**2069**



**2075**















**2172**

# SILL EXTENDERS

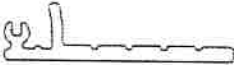
**NOTE: Regenex can make customized profiles to meet your needs.**

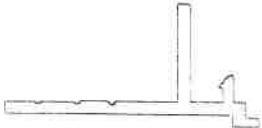
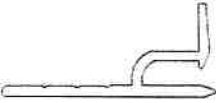
(Shown Actual Size)

 <b>1021</b>	 <b>1027</b>	 <b>1038</b>
 <b>1039</b>	 <b>1040</b>	 <b>1043</b>
 <b>1052</b>	 <b>1057</b>	 <b>1069</b>
 <b>1100</b>	 <b>1210</b>	 <b>1219</b>
 <b>2036</b>	 <b>2046</b>	 <b>2055</b>

# SILL EXTENDERS

**NOTE: Regenex can make customized profiles to meet your needs.**

(Shown Actual Size)



**2056**

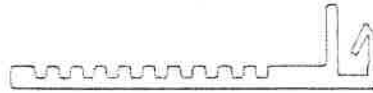

**2101**

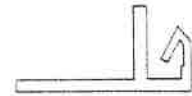

**2105**



**2600**



**2177**



**2187**



**2220**



**2308**



**2429**

# NAIL FIN

**NOTE: Regenex can make customized profiles to meet your needs.**

**(Shown Actual Size)**



**1023**



**1028**

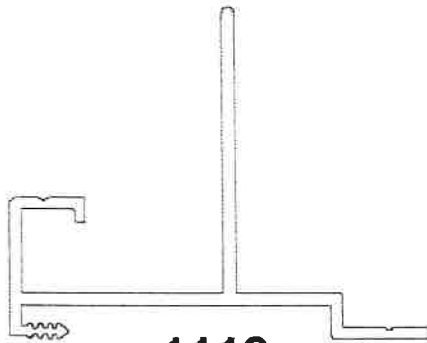

**1113**

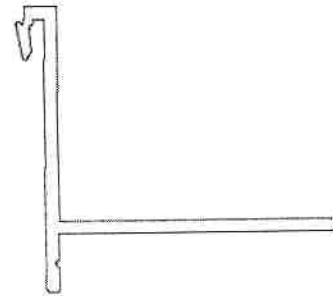

**2096**

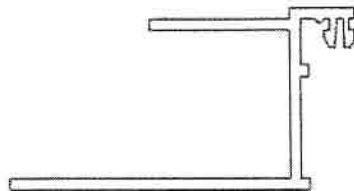

**2108**

---

---

# NAIL FIN

---

---

**NOTE: Regenex can make customized profiles to meet your needs.**

**(Shown Actual Size)**

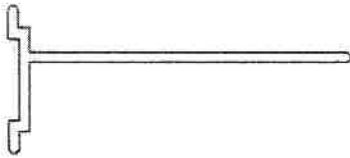

**2200**



**2238**

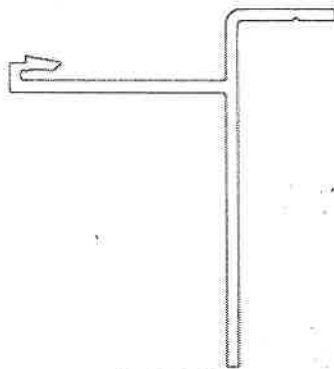

**2430**

# — GLAZING BEAD/GLASS STOPS —

**NOTE: Regenex can make customized profiles to meet your needs.**

(Shown Actual Size)

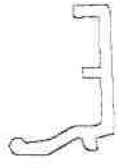

**1033**

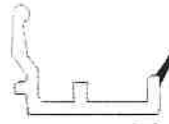

**1033F**



**1042**



**1050**

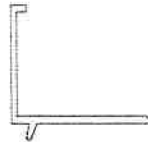

**1056**



**1083**



**1084**

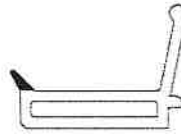

**1109**



**1213**



**2032**

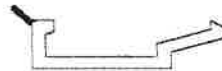

**2032F**

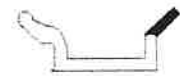

**2058**

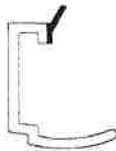

**2074**



**2078**



**2087**

# — GLAZING BEAD/GLASS STOPS —

**NOTE: Regenex can make customized profiles to meet your needs.**

**(Shown Actual Size)**



**2148**

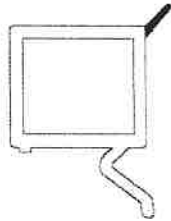

**2149**



**2150**



**8207**



**8208**



**2300**

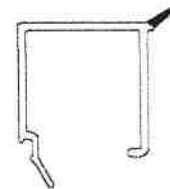

**2426**

# — SCREEN TRACK FILLERS —

**NOTE: Regenex can make customized profiles to meet your needs.**

(Shown Actual Size)



**1030**

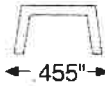

**1030T**

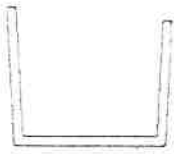

**1111**



**1111A**



**2029**



**2029M**

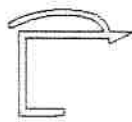

**2071**



**2079**

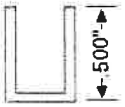

**2103**

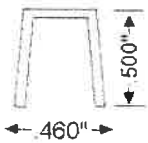

**2103T**



**2184**



**2185**



# ADAPTERS

NOTE: Regenex can make customized profiles to meet your needs.

(Shown Actual Size)

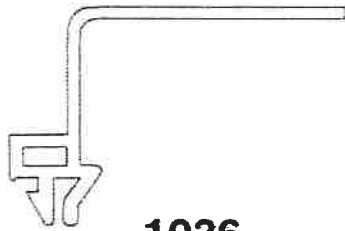

1036

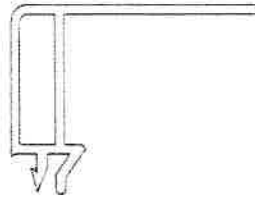

1037

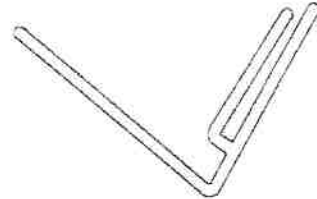

1076

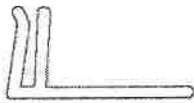

2212

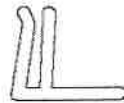

2213

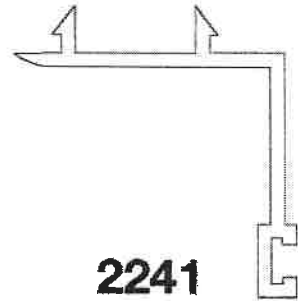

2241

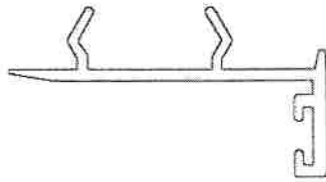

2314

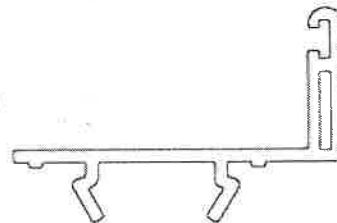

2422

# MISC. PROFILES

NOTE: Regenex can make customized profiles to meet your needs.

(Shown Actual Size)

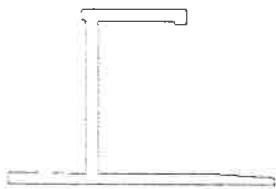

1014



1044

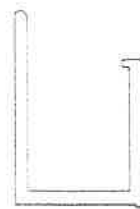

1074



1088

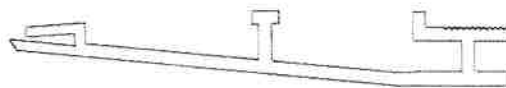

1094

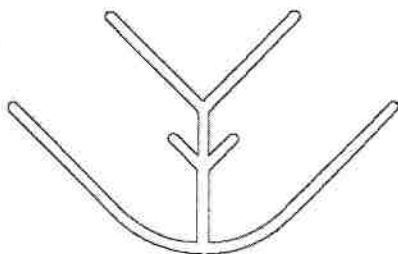

1097

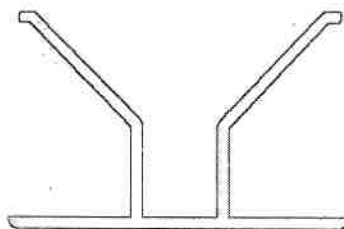

1215



1999

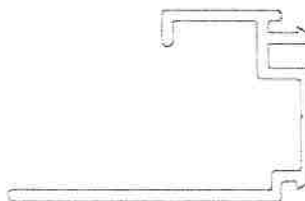

2047



2061

# MISC. PROFILES

NOTE: Regenex can make customized profiles to meet your needs.

(Shown Actual Size)

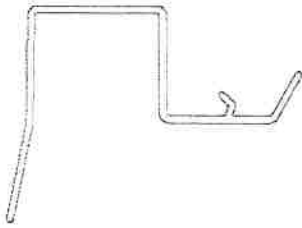

**2084**

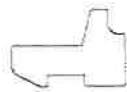

**2097**



**2098**



**2099**



**2100**

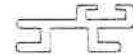

**2109**



**2111**



**2112**



**2113**

# MISC. PROFILES

NOTE: Regenex can make customized profiles to meet your needs.

(Shown Actual Size)

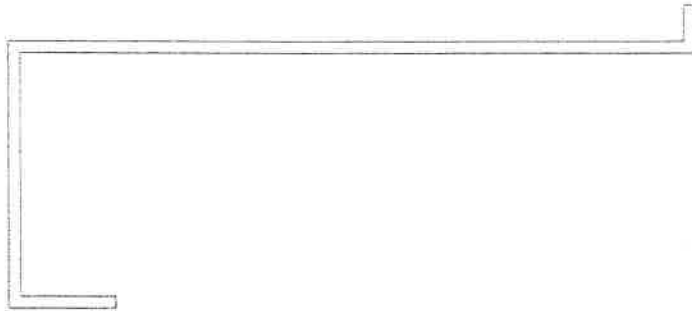

**2114**

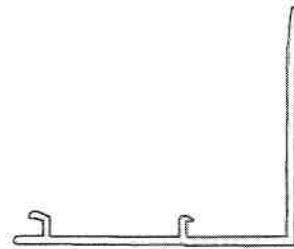

**2224**



**2137**

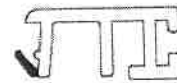

**2151**

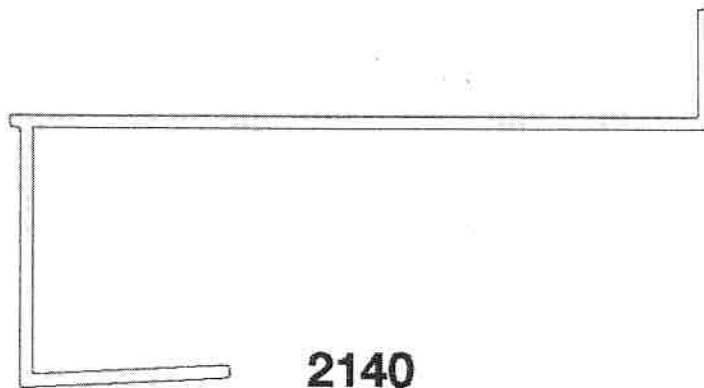

**2140**

# MISC. PROFILES

NOTE: Regenex can make customized profiles to meet your needs.

(Shown Actual Size)

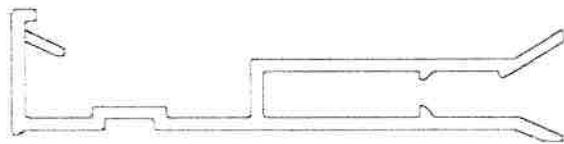

2145



2153

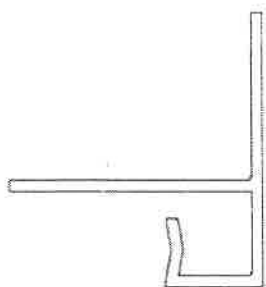

2157



2158

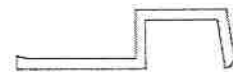

2175

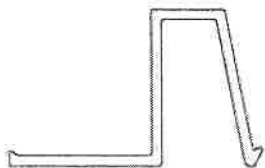

2176

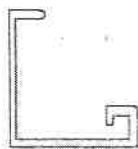

2194

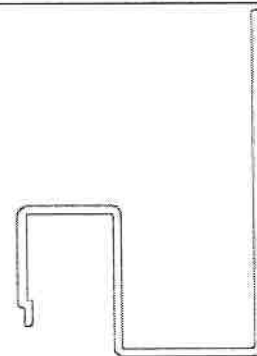

2191

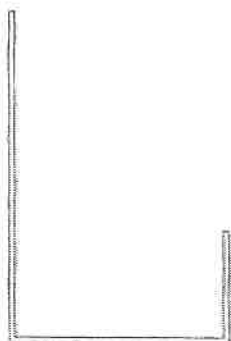

2321

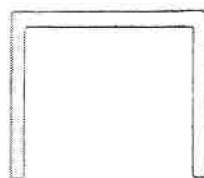

2505

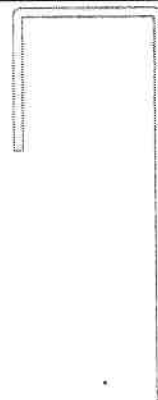

6016

---

---

# MISC. PROFILES

---

---

**NOTE: Regenex can make customized profiles to meet your needs.**

**(Shown Actual Size)**

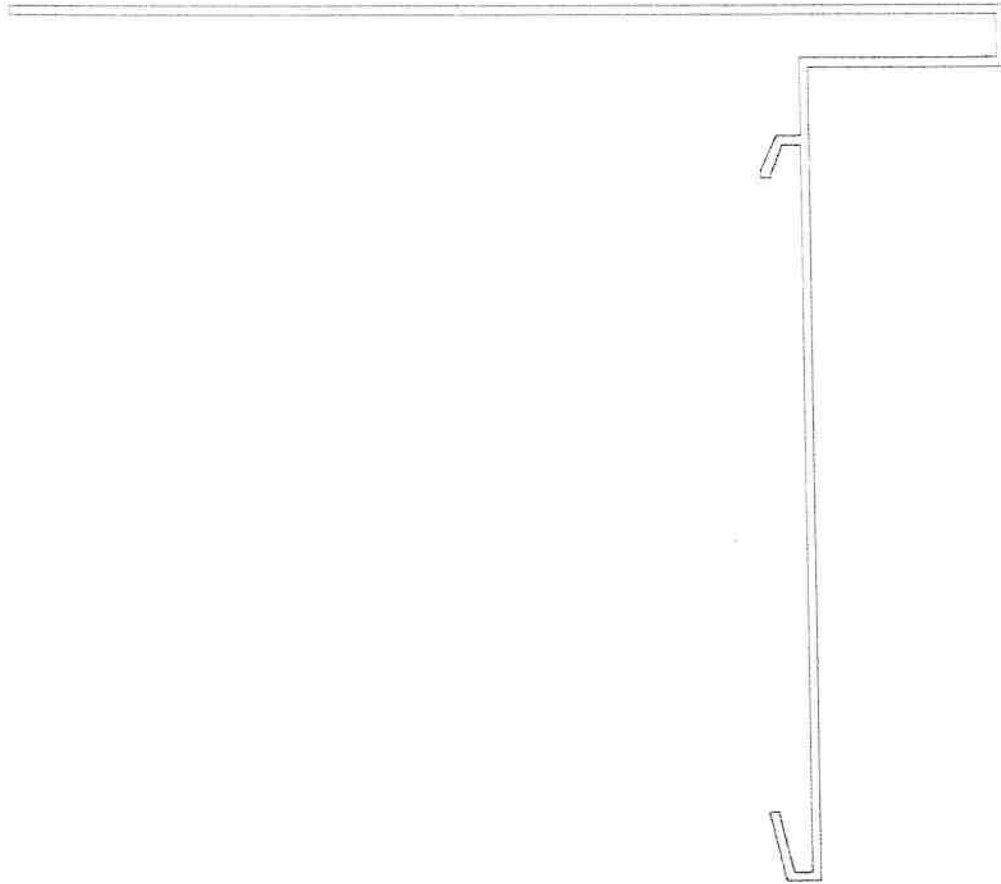

**3005**